

User Manual

MP-SC-9T

4K Scaler Switcher



All Rights Reserved

Version: MP-SC-9T_2018V1.0

Preface

Read this user manual carefully before using the product. Pictures are shown in this manual for reference only. Different models and specifications are subject to real product.

This manual is only for operation instruction, please contact the local distributor for maintenance assistance. The functions described in this version were updated till September, 2018. In the constant effort to improve the product, we reserve the right to make functions or parameters changes without notice or obligation. Please refer to the dealers for the latest details.

FCC Statement

This equipment generates, uses and can radiate radio frequency energy and, if not installed and used in accordance with the instructions, may cause harmful interference to radio communications. It has been tested and found to comply with the limits for a Class B digital device, pursuant to part 15 of the FCC Rules. These limits are designed to provide reasonable protection against harmful interference in a commercial installation.

Operation of this equipment in a residential area is likely to cause interference, in which case the user at their own expense will be required to take whatever measures may be necessary to correct the interference.

Any changes or modifications not expressly approved by the manufacture would void the user's authority to operate the equipment.



SAFETY PRECAUTIONS

To ensure the best from the product, please read all instructions carefully before using the device. Save this manual for further reference.

- Unpack the equipment carefully and save the original box and packing material for possible future shipment
- Follow basic safety precautions to reduce the risk of fire, electrical shock and injury to persons.
- Do not dismantle the housing or modify the module. It may result in electrical shock or burn.
- Using supplies or parts not meeting the products' specifications may cause damage, deterioration or malfunction.
- Refer all servicing to qualified service personnel.
- To prevent fire or shock hazard, do not expose the unit to rain, moisture or install this product near water.
- Do not put any heavy items on the extension cable in case of extrusion.
- Do not remove the housing of the device as opening or removing housing may expose you to dangerous voltage or other hazards.
- Install the device in a place with fine ventilation to avoid damage caused by overheat.
- Keep the module away from liquids.
- Spillage into the housing may result in fire, electrical shock, or equipment damage. If an object or liquid falls or spills on to the housing, unplug the module immediately.
- Do not twist or pull by force ends of the cable. It can cause malfunction.
- Do not use liquid or aerosol cleaners to clean this unit. Always unplug the power to the device before cleaning.
- Unplug the power cord when left unused for a long period of time.
- Information on disposal for scrapped devices: do not burn or mix with general household waste, please treat them as normal electrical wastes.

Table of Content

1. Product Introduction	1
1.1 Features	1
1.2 Package List	2
2. Specification	3
3. Panel Description	4
3.1 Front Panel	4
3.2 Rear Panel	5
4. System Connection	7
4.1 Usage Precaution	7
4.2 System Diagram	7
4.3 Microphone Connection	7
5. Button Control	11
5.1 Manual Switching	11
5.2 Auto Switching	11
5.3 Volume Adjustment	11
6. IR Control	12
6.1 IR Remote Control	12
6.2 IR Pass-through Control	13
6.2.1 To Control Far-end Source/Display	13
6.2.2 To Control Local Source/MP-SC-9T	13
7. RS232 Control	14
7.1 RS232 Connection	14
7.2 RS232 Control Software	14
7.3 RS232 Command	16
8. GUI Control	19
8.1 Control Menu	20
8.2 Volume Menu	21
8.3 Configuration Menu	22
8.4 Password Menu	24
8.5 GUI Update	24
9. OSD Control	25
10. Panel Drawing	26
11. Troubleshooting and Maintenance	27
12. Customer Service	28

1. Product Introduction

The MP-SC-9T is a 9 inputs multi format A/V presentation auto 4k Scaler Switcher that scales video signals to HDMI and HDBaseT outputs simultaneously. The HDBaseT output supports 48V PoH and can connect to a compatible HDBaseT Receiver up to a maximum of 100 meters (328ft).

With 1 IR ALL IN and 1 IR ALL OUT, the IR control signals can be transmitted bi-directionally between the MP-SC-9T and compatible HDBaseT Receiver or HDBaseT Transmitter.

The MP-SC-9T can be controlled either by front panel buttons, IR Remote, RS232 or GUI. With a microphone input that supports phantom power and a balanced stereo audio output for audio reinforcement, the MP-SC-9T can handle a myriad of A/V applications.

1.1 Features

- Compliant with HDMI 1.4 and HDCP 2.2.
- Supports video source auto-switching function.
- HDBaseT input with distances up to 70m (230ft) at 1080p and 40m (131ft) at 4K on a single CAT5e/6/7 cable.
- HDBaseT output with distances up to 100m (328ft) at 1080p and 70m (230ft) at 4Kx2K on a single CAT5e/6/7 cable.
- Output resolutions selectable to assure preferred output, and supports various output resolutions, such as 1280x720(default), 1920x1080, 1024x768, 1360x768, 3840x2160@30Hz, 3840x2160@60Hz.
- DP, HDMI and VGA video inputs can be embedded with external audio.
- Support Line or Mic audio inputs, and MIC port supports balance/unbalance signal, suppress the external noise effectively.
- Controllable via buttons, IR Remote, RS232 and GUI.
- Powerful OSD function.
- Bi-directional IR and RS232 pass-through.
- Convenient firmware update port.

4K Compact Scaler Switcher

1.2 Package List

Scaler Switcher	<ul style="list-style-type: none">● 1x MP-SC-9T Scaler Switcher● 2x Mounting Ears with 6 Screws● 4x Plastic Cushions● 1x IR Remote● 1x IR Receiver● 1x IR Emitter● 6x 3-Pin Phoenix Connectors● 1x 5-Pin Phoenix Connector● 1x RS232 Cable (3-Pin to DB9)● 1x Power Cord
HDBaseT Receiver	<ul style="list-style-type: none">● 1x HDBaseT Receiver● 2x Mounting Ears with 2 Screws● 4x Plastic Cushions● 1x RS232 Cable (3-Pin to DB9)
	<ul style="list-style-type: none">● 1x User Manual

Note: Please contact your distributor immediately if any damage or defect in the components is found.

2. Specification

Video	
Video Input	(1) HDBaseT;(1) Display Port; (5) HDMI; (2) VGA
Video Input Connector	(1) RJ45; (1) Female Display Port; (5) Type A HDMI; (2) 15-pin Female VGA
Input Video Resolution	Up to 4Kx2K@60Hz 4:2:0
Video Output	(1) HDMI; (1) HDBaseT
Video Output Connector	(1) Type A HDMI; (1) RJ45
Output Video Resolution	1280x720 (default), 1920x1080, 1024x768, 1360x768, 3840x2160@30Hz, 3840x2160@60Hz
Video Standards	HDMI 1.4 and HDCP 2.2
Audio	
Audio Input	(1) Stereo Audio Input for 2-DP; (1) Stereo Audio Input for 3-HDMI; (2) Stereo Audio Inputs for 8-VGA and 9-VGA; (1) LINE Audio; (1) MIC Audio
Audio Input Connector	(4) 3.5mm Stereo Jacks; (2) 3-pin Phoenix Connector
Audio Input Impedance	>10kΩ
Audio Output	(1) Dual-Mono Analog Audio; (1) Power Amplifier with Fixed Voltage
Audio Output Connector	(1) 5-pin Phoenix Connector; (1) 3-pin Phoenix Connector
Audio Output Impedance	70Ω
Frequency Response	20Hz~20K Hz
Stereo Channel Separation	≥80dB@1KHz
Control Part	
Control Port	(1) FIRMWARE; (1) IR EYE; (1) IR ALL IN; (1) IR ALL OUT; (3) RS232; (1) TCP/IP
Control Connector	(1) Type-A USB (3) 3.5mm Mini Jacks; (3) 3-pin Phoenix Connectors; (1) RJ45
General	
Transmission Distance	HDBaseT Input: 1080p≤70m, 4Kx2K≤40m; HDBaseT Output: 1080p≤100m, 4Kx2K≤70m.
Operation Temperature	-10 ~ +55°C
Storage Temperature	-25 ~ +70°C
Relative Humidity	10%-90%
External Power Supply	100V~240V AC
Power Consumption	45W (Max)
Dimension (W*H*D)	436.4mm x 44mm x 276.5mm
Net Weight	3.17Kg

3. Panel Description

3.1 Front Panel

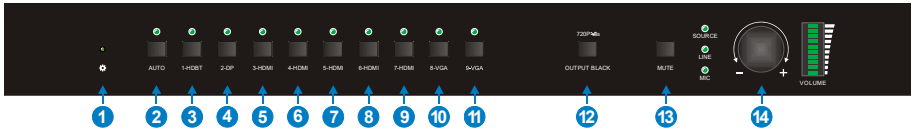

- ① Power Indicator:
 - Off when there is no power to the device.
 - Green when the device is in standby mode.
 - Red when the device is powered on.
- ② Auto switching mode selector and activity LED
- ③ 1-HDBT input selector and activity LED
- ④ 2-DP input selector and activity LED
- ⑤ 3-HDMI input selector and activity LED
- ⑥ 4-HDMI input selector and activity LED
- ⑦ 5-HDMI input selector and activity LED
- ⑧ 6-HDMI input selector and activity LED
- ⑨ 7-HDMI input selector and activity LED
- ⑩ 8-VGA input selector and activity LED
- ⑪ 9-VGA input selector and activity LED
- ⑫ OUTPUT BACK/720P: Press this to let the display be black screen or long-press for 3 seconds to reset the output resolution to 1280×720p.
- ⑬ MUTE: Press this to mute output.
- ⑭ Volume Knob
Press this knob to select AMP (amplifier), SOURCE or MIC audio input, and then turn the knob to adjust the volume.

4K Compact Scaler Switcher

3.2 Rear Panel

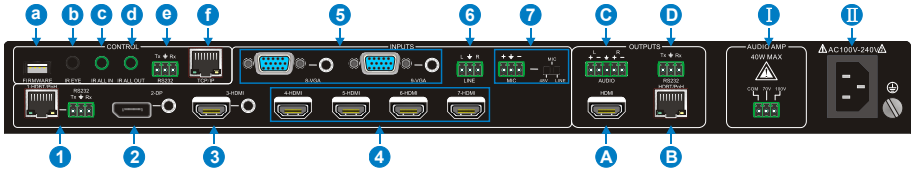

INPUTS:

- ① 1-HDBT/PoH and RS232:
 - HDBaseT input port: supports 48V PoH, connect with an HDBaseT Transmitter to receive AV signal or IR/RS232 control signal.
 - The RS232 port and that one on HDBaseT Transmitter can transmit RS232 commands each other by pass-through function.
- ② 2-DP: DP input with external audio input.
- ③ 3-HDMI: HDMI input port with external audio input, supports 4k@60Hz 4:2:0, HDCP 2.2.
- ④ 4-HDMI~7-HDMI: 4 HDMI input ports, supports 4k@60Hz 4:2:0, HDCP 2.2.
- ⑤ 8-VGA~9-VGA: 2 VGA input ports with VGA auxiliary audio inputs.
- ⑥ LINE: Line audio input port.
- ⑦ MIC: MIC audio input port. DIP switch for selecting the below 3 mode:
 - 48V phantom power mode (connect with condenser microphone).
 - MIC mode (connect with dynamic microphone).
 - LINE mode (connect with wireless microphone or line audio).

OUTPUTS:

- A. HDMI: HDMI video output port.
- B. HDBT/PoH: Supports 48V PoH. Connect with an HDBaseT Receiver to transmit AV signal or IR/RS232 control signal.
- C. AUDIO: Audio output port, the audio comes from the input audio corresponding to the selected video source and is mixed with MIC audio.
- D. RS232: The RS232 port and that one on HDBaseT Receiver can transmit RS232 commands each other by pass-through function.

4K Compact Scaler Switcher

CONTROL:

- a. **FIRMWARE:** Type-A USB port for updating system firmware or loading customized EDID data.
- b. **IR EYE:** Connect with IR Receiver (with carrier wave only) to receive IR signal send by IR Remote to control this Scaler Switcher.
- c. **IR ALL IN:** IR input port used with far-end IR output port. Connect with IR Receiver (with carrier) to receive IR signal from all kinds of IR Remote to control far-end devices from local.
- d. **IR ALL OUT:** IR output port used with far-end IR input port. Connect with IR emitter (with carrier) to send IR signal to control local devices from remote.
- e. **RS232:** Serial port, 3-pin phoenix connector, connect with a control device (such as PC) to control MP-SC-9T.
- f. **TCP/IP:** Ethernet port, connect PC to control MP-SC-9T via GUI.

I: AUDIO AMP: Audio output port, connect with 70V/100V constant voltage audio amplifier.

II: AC100V-240V: Power port, connect to an AC 100V~240V power via the included power cord.

4. System Connection

4.1 Usage Precaution

- Verify all components and accessories included before installation.
- Make sure all components and accessories included before installation.
- System should be installed in a clean environment with proper temperature and humidity.
- All of the power switches, plugs, sockets, and power cords should be insulated and safe.
- All devices should be connected before power on.

4.2 System Diagram

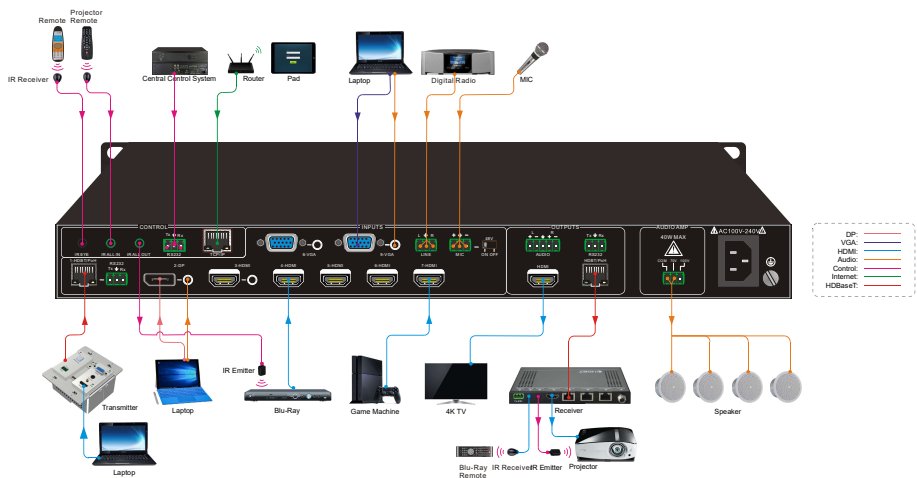

4.3 Microphone Connection

MP-SC-9T provides with one 3-level microphone input port, to accommodate different microphone input modes, including 48V phantom power mode, MIC mode and LINE mode.

➤ 48V phantom power Mode

48V phantom power input has a good frequency characteristic, high input impedance and high sensitivity.

When switching to “48V”, the MIC input will provide a 48V phantom power. This is only

4K Compact Scaler Switcher

used for **condenser microphone**.

Connect the microphone in this way: "+" connects to positive, "-" connects to negative and " \equiv " to ground.

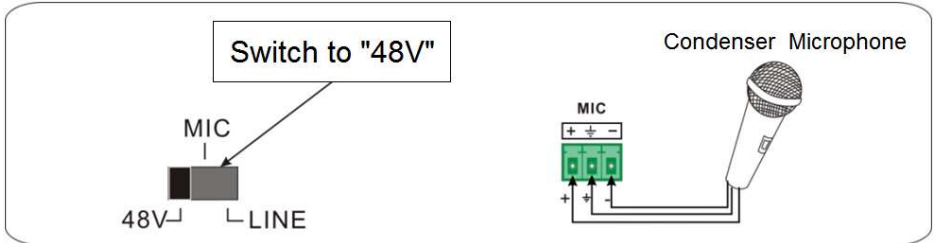

➤ MIC Mode

MIC input has a low frequency characteristics, and wide frequency response.

When switch to "MIC", the microphone input is used for connecting with **dynamic microphone**. There are two different connection methods:

① Unbalanced connection:

"+" and " \equiv " connect to ground, and "-" connects to signal.

"-" and " \equiv " connect to ground, and "+" connects to signal.

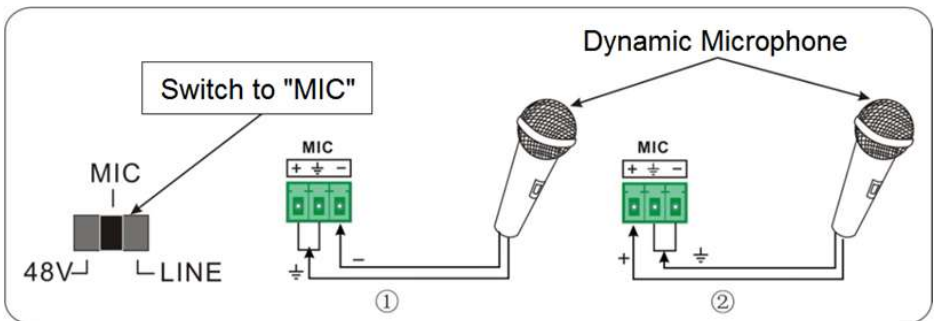

4K Compact Scaler Switcher

- ② Balanced connection: “+” connects to positive, “-” connects to negative and “ ⏏ ” connects to ground.

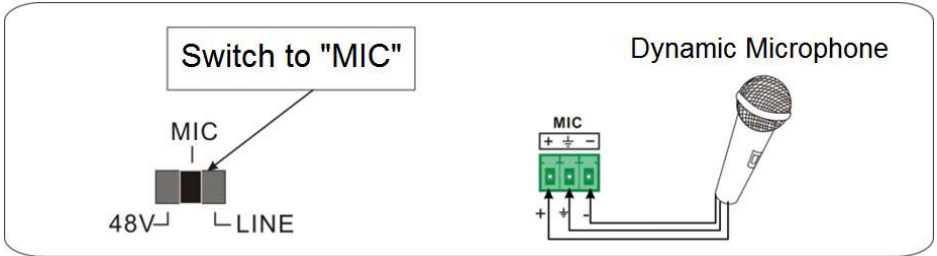

➤ LINE Mode

LINE input has a low frequency characteristics, and wide frequency response.

When switch to “LINE”, the microphone input is used for connecting with line audio or wireless microphone output. There are two different connection methods:

- ① Unbalanced connection:

“+” and “ ⏏ ” connect to ground, and “-” connects to signal.

“-” and “ ⏏ ” connect to ground, and “+” connects to signal.

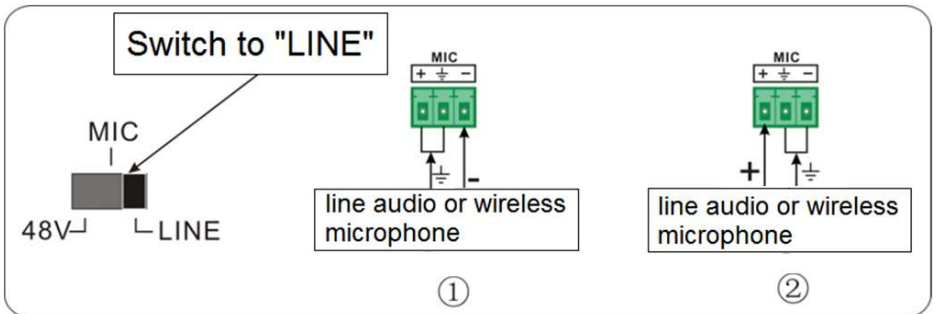

4K Compact Scaler Switcher

- ② Balanced connection: “+” connects to positive, “-” connects to negative and “ \equiv ” connects to ground.

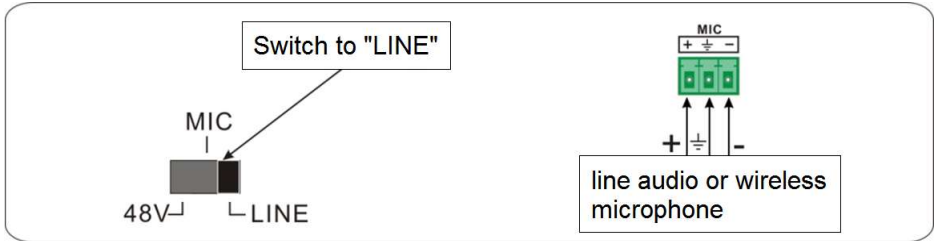

5. Button Control

Front panel buttons can be used for switching operations and volume adjusting.

5.1 Manual Switching

Press **1-HDBT/PoH**, **2-DP**, **3-HDMI**, **4-HDMI**, **5-HDMI**, **6-HDMI**, **7-HDMI**, **8-VGA**, or **9-VGA** on front panel to select the corresponding input source.

5.2 Auto Switching

Press **AUTO** to enter in auto-switching mode.

The auto-switching mode abides by the following principles:

- **New input**
Once detecting a new input signal, the switcher would switch to this new signal automatically.
- **Rebooting device**
MP-SC-9T have the ability to save the last configuration before losing power. If the last switching mode is auto-switching, once rebooted, the switcher will automatically enter auto-switching mode, then detect all inputs and memorize their connection status for future rebooting using. If the last displayed signal is still available, the unit will output the signal. If not, the unit will detect all the input signals with priority from 1-HDBT/PoH to 9-VGA. When detected the first signal, it will transfer to output.
- **Signal removal**
Once removing the current display signal, MP-SC-9T will detect all input signals with priority from 1-HDBT/PoH to 9-VGA. It will transfer the signal firstly detected to be available to output devices.

Note:

- *When the DP signal is switched as input, the DP source device may not read the EDID data from display device, at this point re-plug the DP source device to solve this phenomenon.*
- *Auto-switching function works only when inputting new signal, removing a signal or power rebooting.*

5.3 Volume Adjustment

Press **Volume Knob** to choose AMP, SOURCE or MIC audio needed to be adjusted, the corresponding LED will turn green and keep on, and then adjust the Volume Knob to increase or decrease sound volume.

6. IR Control

6.1 IR Remote Control

Connect IR Receiver to the **IR EYE** port, MP-SC-9T can be controlled by using the IR Remote as below.

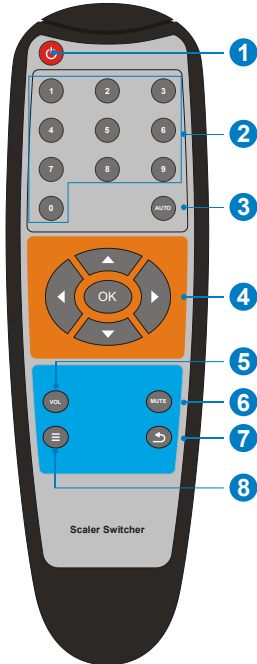

- ① Enter/ exit standby mode.
- ② Input channel selection buttons (1~9): Select video source via pressing corresponding button (audio switched following the corresponding 2-DP/3-HDMI/8-VGA/9-VGA).
- ③ Auto: Enter/Exit auto-switching mode.
- ④ OK: confirm button; Navigation buttons: UP/DWON/LEFT/ RIGHT button, for value setting or page-turn.
- ⑤ VOL: Volume adjusting button. After pressing this button, the volume adjusting menu will be showed on Display, and then press UP/DWON button to increase/decrease volume.
- ⑥ Mute/ unmute audio.
- ⑦ Exit button: Exit OSD menu or current operation.
- ⑧ Enter OSD menu or used to return to previous menu.

Important notice:

- Please use this IR Remote carefully.
- Please wipe the surface using clean towels or absorbent soft cloth.
- To reduce the risk of fire or electric shock do not expose this apparatus to rain or moisture.
- While installing the battery, put electrodes in the right position to avoid short circuit.
- The battery shall not be exposed to excessive heat such as sunshine, fire or the like.
- Do not ingest battery. Chemical Burn Hazard.
- Please remove the battery when not in use.
- Do not mixed use the old and new battery, or different types.
- Keep new and used batteries away from children. If the battery compartment does not close securely, stop using the product and keep it away from children.
- Dispose of used batteries promptly according to local recycling or waste regulations.

6.2 IR Pass-through Control

6.2.1 To Control Far-end Source/Display

Connect an IR Receiver to **IR ALL IN** port on the MP-SC-9T, and then connect IR emitter to the **IR OUT** ports on the HDBaseT Transmitter and Receiver, the far-end source/display can be control by their IR Remote.

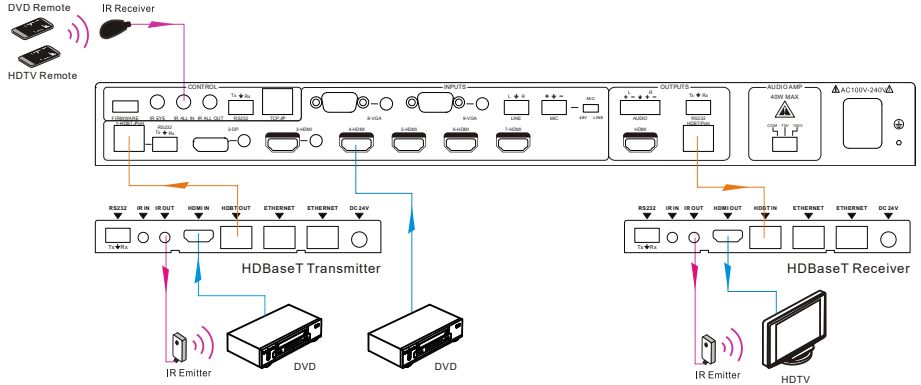

6.2.2 To Control Local Source/MP-SC-9T

Connect an IR emitter to **IR ALL OUT** port on the MP-SC-9T, and then connect IR Receiver to the **IR IN** ports on the HDBaseT Transmitter and Receiver, the source devices or MP-SC-9T can be control by their IR Remote.

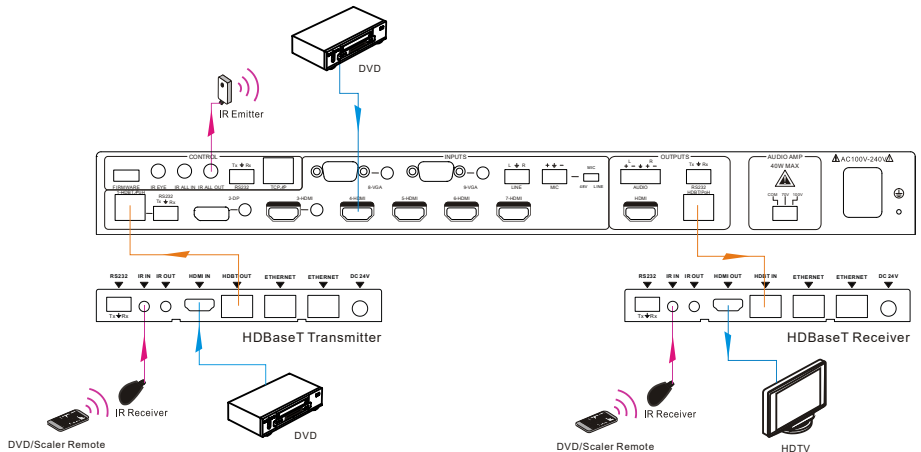

7. RS232 Control

7.1 RS232 Connection

Connect the control PC to the RS232 port as shown as below:

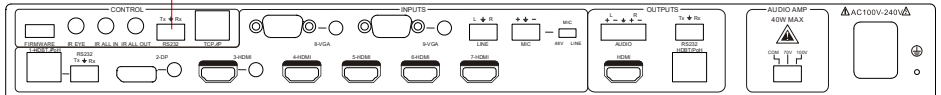
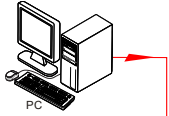

The baud rate support 2400, 4800, 9600(default), 19200, 38400, 57600 or 115200.

7.2 RS232 Control Software

- **Installation** Copy the control software file to the computer connected with MP-SC-9T.
- **Uninstallation** Delete all the control software files in corresponding file path.

- **Basic Settings:**

First to connect MP-SC-9T with all input devices and output devices needed, then to connect it with a computer which is installed with RS232 control software.

Double-click the software icon to run this software.

Here we take the software **CommWatch.exe** as example. The icon is showed as below:



4K Compact Scaler Switcher

The interface of the control software is showed as below:

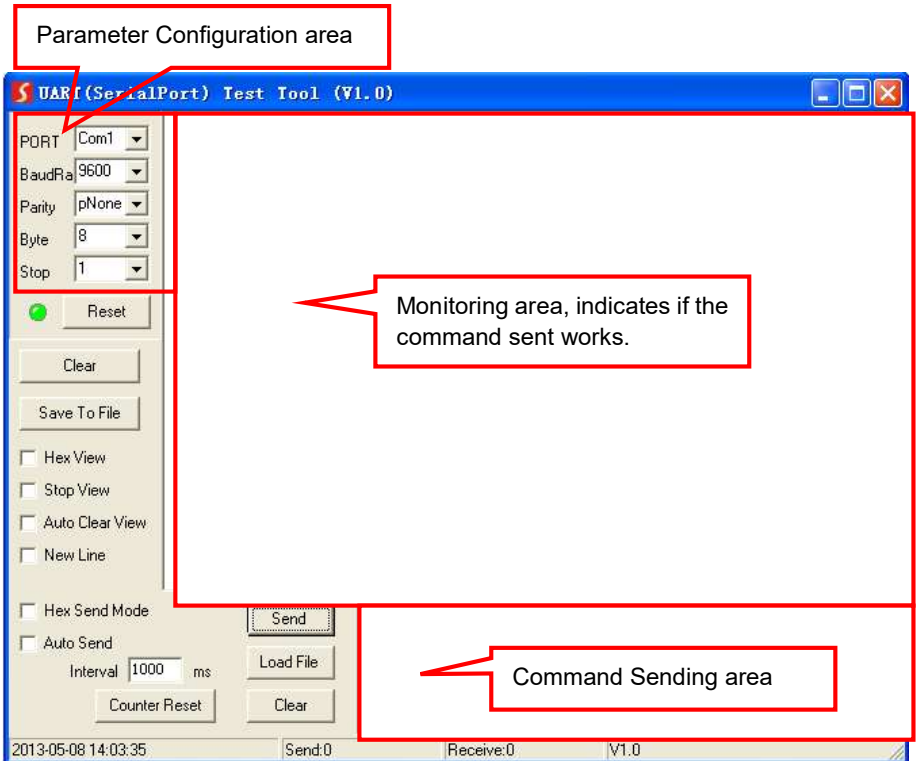

Please set the parameters of COM number, bound rate, data bit, stop bit and the parity bit correctly, and then you are able to send command in Command Sending Area.

4K Compact Scaler Switcher

7.3 RS232 Command

Communication protocol: RS232 Communication Protocol

Baud rate: 9600

Data bit: 8

Stop bit: 1

Parity bit: none

Note: All commands must be ended with "<CR><LF>".

Command	Function	Feedback
update	Software update.	update
Factory	Reset to factory default.	Factory reset
Menu	Open OSD menu.	Key menu
Up	UP button.	Key up
Down	DOWN button.	Key down
Left	LEFT button.	Key left
Right	RIGHT button.	Key right
Exit	EXIT button (exit OSD).	Key exit
Ok	OK for OSD selection.	Key ok
Hdbtin	Switch to 1-HDBT input.	Port 1
Dpin	Switch to 2-DP input.	Port 2
Hdmi3	Switch to 3-HDMI input.	Port 3
Hdmi4	Switch to 4-HDMI input.	Port 4
Hdmi5	Switch to 5-HDMI input.	Port 5
Hdmi6	Switch to 6-HDMI input.	Port 6
Hdmi7	Switch to 7-HDMI input.	Port 7
VGA8	Switch to 8-VGA input.	Port 8
VGA9	Switch to 9-VGA input.	Port 9
4k2k60	Set output resolution to 4Kx2K@60Hz.	4k2k60
4k2k30	Set output resolution to 4Kx2K@30Hz.	4k2k30
108060	Set output resolution to 1080p@60Hz.	108060
1280720	Set output resolution to 1280x720.	1280720
1024768	Set output resolution to 1024x768.	1024768
1360768	Set output resolution to 1360x768.	1360768
Redid	Restore the default EDID.	RestoreEDID

4K Compact Scaler Switcher

Command	Function	Feedback
Setedid	Set the input source device to read the EDID from output.	xxxxx...
DP audio1	Select embedded audio input for 2-DP video signal.	DP audio embedded
DP audio2	Select external audio input for 2-DP video signal.	DP audio external
HDMI audio1	Select embedded audio input for 3-HDMI video signal.	HDMI audio embedded
HDMI audio2	Select embedded audio input for 3-HDMI video signal.	HDMI audio external
Ampadd	Increase the volume of AMP audio.	amp volume: xx
Ampmin	Decrease the volume of AMP audio.	amp volume: xx
Sourceadd	Increase the volume of source audio.	source volume: xx
Sourcemin	Decrease the volume of source audio.	source volume: xx
Micadd	Increase the volume of MIC.	mic volume: xx
Micmin	Decrease the volume of MIC.	mic volume: xx
Mute	Mute all audio.	Audio All Mute
Unmute	Unmute all audio.	Audio All Unmute
Micmute	Mute MIC audio.	Micmute
Micunmute	Unmute MIC audio.	Micunmute
Sourcemute	Mute SOURCE audio.	Sourcemute
Sourceunmute	Unmute SOURCE audio.	Sourceunmute
Ampmute	Mute AMP audio.	Ampmute
Ampunmute	Unmute AMP audio.	Ampunmute
Output?	Get the output resolution.	4k2k60
		4k2k30
		1280720
		1024768
		1360768
Audio?	Get the input audio type.	HDMI external

4K Compact Scaler Switcher

Command	Function	Feedback
		HDMI embedded
		DP external
		DP embedded
Input?	Get the input source.	Hdbt
		Dp
		Hmdi3
		Hmdi4
		Hmdi5
		Hmdi6
		Hmdi7
		Vga8
Volume?	Get the audio volume.	amp volume: xx
		source volume: xx
		mic volume: xx
		Mute/Unmute
Svol:xx	Set the volume of source audio.	source volume: xx
Avol:xx	Set the volume of AMP audio.	amp volume: xx
Mvol:xx	Set the volume of MIC audio.	mic volume: xx
Version	Get the firmware version.	V1.0.0

Note: The input video can't support 4Kx2K@50Hz, otherwise, the output resolution cannot be upscaled as 4Kx2K@60Hz.

8. GUI Control

In addition to control MP-SC-9T via front panel button, IR Remote and RS232 communication software. MP-SC-9T can be controlled via GUI. It allows users to interact with MP-SC-9T through graphical icons and visual indicators.

Type **192.168.0.178** in your browser, it will enter the log-in interface shown as below:

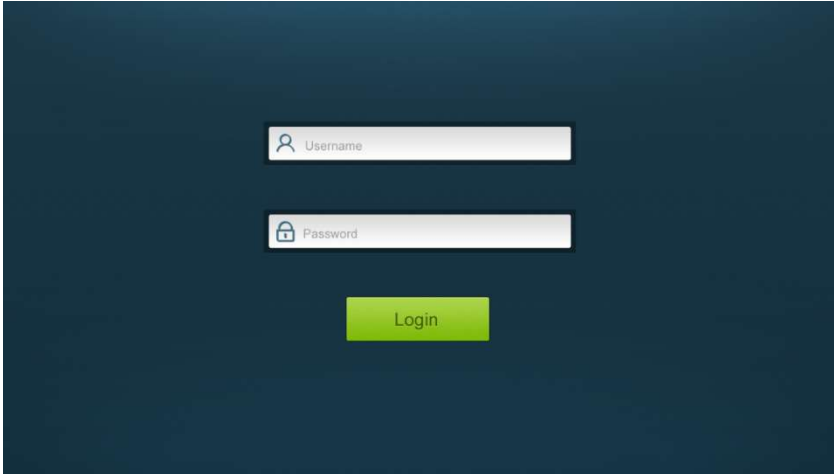

The screenshot shows a login interface with a dark blue background. It features two white input fields. The top field is labeled "Username" and contains a person icon. The bottom field is labeled "Password" and contains a lock icon. Below these fields is a green button labeled "Login".

8.1 Control Menu

Type user name: user and password: user (default setting) on the log-in interface, and then click **Login** to enter Control menu shown as below:

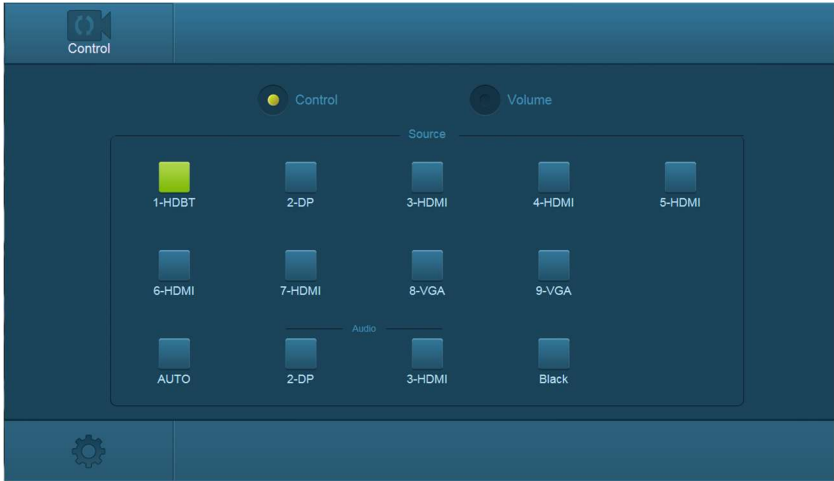

- **Source:** Click the corresponding button (**1-HDBT**, **2-DP**, **3-HDMI**, **4-HDMI**, **5-HDMI**, **6-HDMI**, **7-HDMI**, **8-VGA** or **9-VGA**) to select video input source, or click **AUTO** to enter auto-switching mode.
- **Audio:** Click **2-DP** or **3-HDMI** to select external audio for DP or HDMI video signal.

8.2 Volume Menu

Click **Volume** to enter volume menu shown as below:



- The volume of AMP, Source, and MIC audio can be adjusted.

8.3 Configuration Menu

- ① Click  on control menu to enter setting menu shown as below:

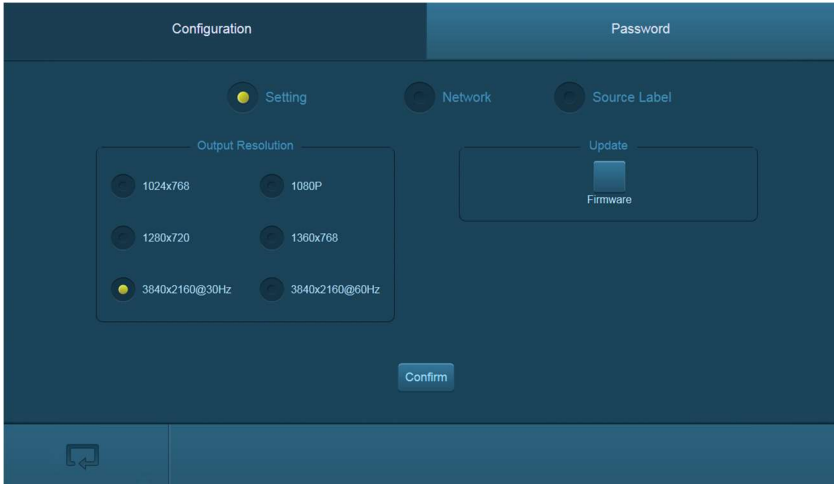

- **Output Resolution:** Select the output resolution that you need and then click **Confirm** to save setting.
- **Update:** Insert the USB flash disk with EDID file/software updating file to FIRMWARE port, and then click EDID/Firmware to start update procedure.

4K Compact Scaler Switcher

- Click **Network** to enter network setting menu shown as below:

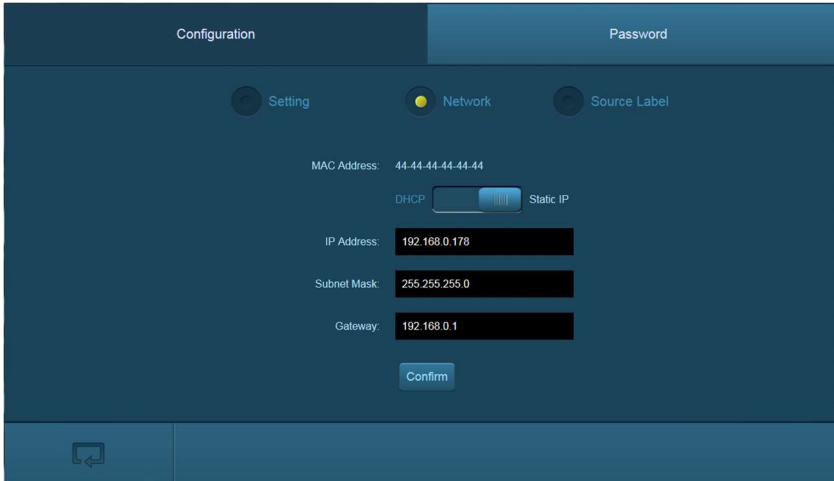

- Dynamic or static IP mode can be selected. Under static IP mode, IP address and subnet mask, gateway can be set and make sure the IP addresses are different to avoid IP conflict.
- Click **Source Label** to enter source label setting menu shown as below:

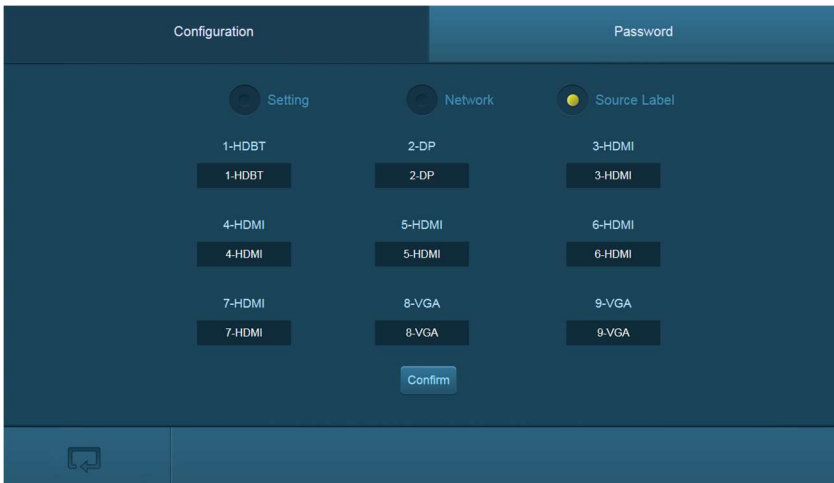

- The name of source input selection button can be modified as you need.

8.4 Password Menu

Click **Password** on the top of interface to enter password menu shown as below:

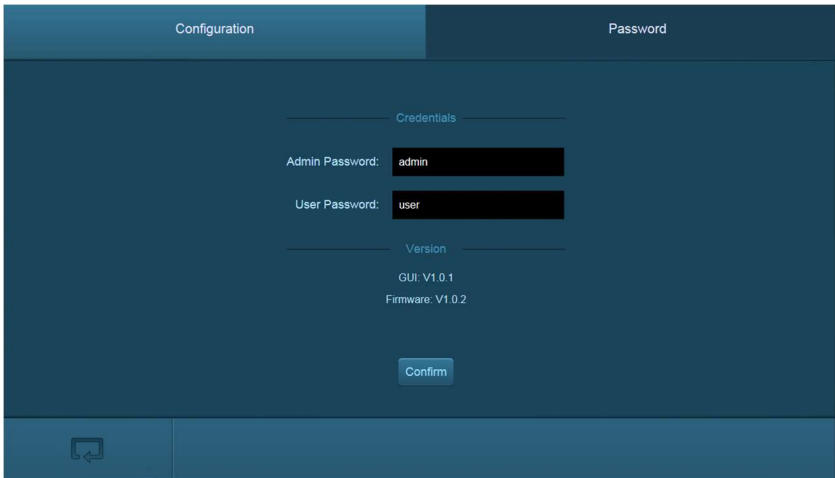

- Admin/user password can be modified as you need.

8.5 GUI Update

GUI for MP-SC-9T supports online update in <http://192.168.0.178:100>. Type the username and password (the same as the GUI log-in settings, modified password will be available only after rebooting) to log in the configuration interface. After that, click **Administration** at the source menu to get to **Upload Program** as shown below:

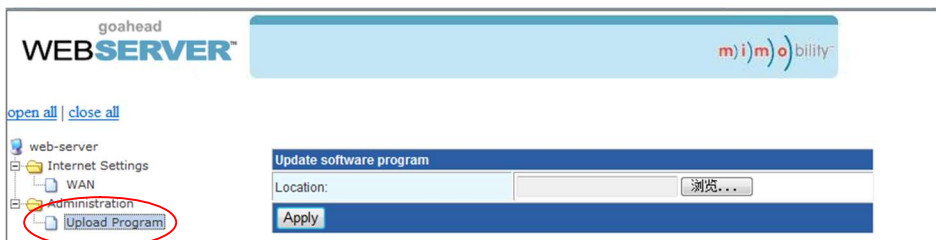

Select the desired update file and press **Apply**, it will start upgrading then.

9. OSD Control

MP-SC-9T provides a powerful OSD operation menu, contains 3 parts: optional settings, image settings, and system setting etc.

There are two ways to enter OSD menu:

- ① Press the MENU button  on IR Remote.
- ② Send the command Menu on RS232 Control Software.

Operation:

- Press direction buttons on IR Remote to switch between menu options and menu pages.
- Press **OK** on the IR Remote to confirm the selection.

OSD MENU-SETUP

Including Software Update, Picture Mode, Color Temperature, Aspect Ratio, Factory Default, Resolution, IP and Software Version.

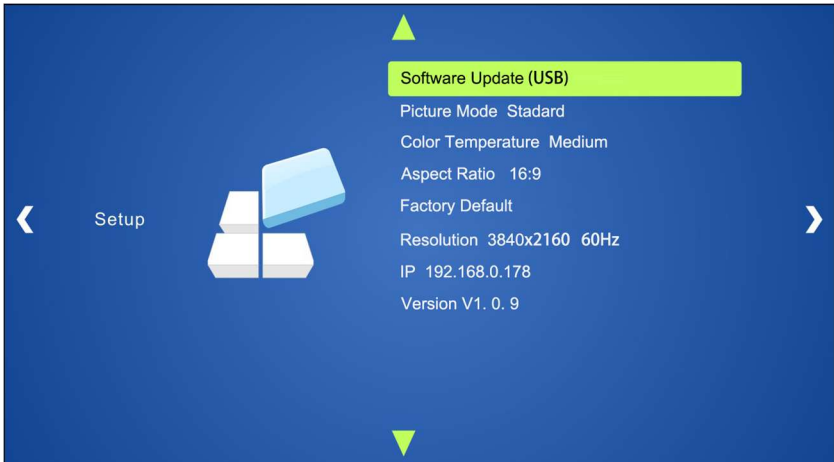

4K Compact Scaler Switcher

10. Panel Drawing

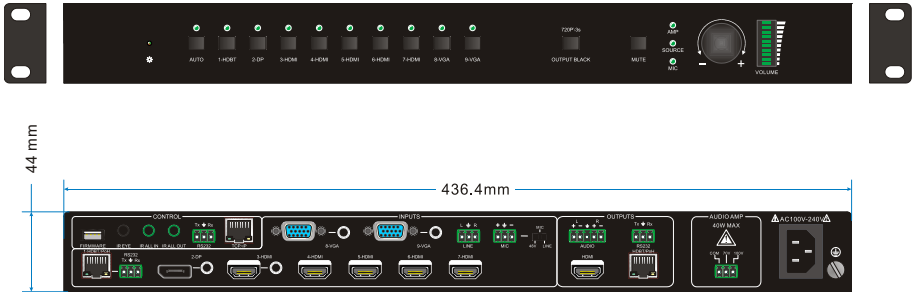

11. Troubleshooting and Maintenance

Problems	Potential Causes	Solutions
Output image with white noise.	Bad quality of the connecting cable	Try another high quality cable.
	Fail or loose connection	Make sure the connection is good
No output image when switching	No signal at the input / output end	Check with oscilloscope or multimeter if there is any signal at the input/ output end.
	Fail or loose connection	Make sure the connection is good.
	The switcher is broken	Send it to authorized dealer for repairing.
POWER indicator doesn't work or no respond to any operation	Fail connection of power cord.	Make sure the power cord connection is good.
Cannot control the device by control device (e.g. a PC) through RS232 port	Wrong RS232 communication parameters	Type in correct RS232 communication parameters.
	Broken RS232 port	Send it to authorized dealer for checking.

Note: If your problem persists after following the above troubleshooting steps, seek further help from authorized dealer or our technical support.

12. Customer Service

The return of a product to our Customer Service implies the full agreement of the terms and conditions hereinafter. These terms and conditions may be changed without prior notice.

1) Warranty

The limited warranty period of the product is fixed three years.

2) Scope

These terms and conditions of Customer Service apply to the customer service provided for the products or any other items sold by authorized distributor only.

3) Warranty Exclusions:

Warranty expiration.

Factory applied serial number has been altered or removed from the product.

Damage, deterioration or malfunction caused by:

- ✓ Normal wear and tear.
- ✓ Use of supplies or parts not meeting our specifications.
- ✓ No certificate or invoice as the proof of warranty.
- ✓ The product model showed on the warranty card does not match with the model of the product for repairing or had been altered.
- ✓ Damage caused by force majeure.
- ✓ Servicing not authorized by distributor.
- ✓ Any other causes which does not relate to a product defect.

Shipping fees, installation or labor charges for installation or setup of the product.

4) Documentation:

Customer Service will accept defective product(s) in the scope of warranty coverage at the sole condition that the defeat has been clearly defined, and upon reception of the documents or copy of invoice, indicating the date of purchase, the type of product, the serial number, and the name of distributor.

Remarks: For further assistance or solutions, please contact your local distributor.