

MPTP-T-101US

4K HDBaseT 2.0™ Extender w/ HDMI® & USB 2.0

KVM support



All Rights Reserved

Version: MPTP-T-101US_2016V1.0

Preface

Read this user manual carefully before using this product. Pictures shown in this manual is for reference only, different model and specifications are subject to real product.

This manual is only for operation instruction only, not for any maintenance usage.

Trademarks

Product model and logo are trademarks. Any other trademarks mentioned in this manual are acknowledged as the properties of the trademark owner. No part of this publication may be copied or reproduced without prior written consent.

FCC Statement

This equipment generates, uses and can radiate radio frequency energy and, if not installed and used in accordance with the instructions, may cause harmful interference to radio communications. It has been tested and found to comply with the limits for a Class B digital device, pursuant to part 15 of the FCC Rules. These limits are designed to provide reasonable protection against harmful interference in a commercial installation.

Operation of this equipment in a residential area is likely to cause interference, in which case the user at their own expense will be required to take whatever measures may be necessary to correct the interference

Any changes or modifications not expressly approved by the manufacture would void the user's authority to operate the equipment.



SAFETY PRECAUTIONS

To insure the best from the product, please read all instructions carefully before using the device. Save this manual for further reference.

- Unpack the equipment carefully and save the original box and packing material for possible future shipment
- Follow basic safety precautions to reduce the risk of fire, electrical shock and injury to persons.
- Do not dismantle the housing or modify the module. It may result in electrical shock or burn.
- Using supplies or parts not meeting the products' specifications may cause damage, deterioration or malfunction.
- Refer all servicing to qualified service personnel.
- To prevent fire or shock hazard, do not expose the unit to rain, moisture or install this product near water.
- Do not put any heavy items on the extension cable in case of extrusion.
- Do not remove the housing of the device as opening or removing housing may expose you to dangerous voltage or other hazards.
- Install the device in a place with fine ventilation to avoid damage caused by overheat.
- Keep the module away from liquids.
- Spillage into the housing may result in fire, electrical shock, or equipment damage. If an object or liquid falls or spills on to the housing, unplug the module immediately.
- Do not twist or pull by force ends of the optical cable. It can cause malfunction.
- Do not use liquid or aerosol cleaners to clean this unit. Always unplug the power to the device before cleaning.
- Unplug the power cord when left unused for a long period of time.
- Information on disposal for scrapped devices: do not burn or mix with general household waste, please treat them as normal electrical wastes.

Contents

1. Introduction	1
1.1 Introduction to MPTP-T-101US.....	1
1.2 Features	1
1.3 Packing List	1
2. Panel Description.....	2
2.1 MPTP-T-101UST	2
2.2 MPTP-T-101USR.....	3
3. System Connection.....	5
3.1 Usage Precautions	5
3.2 System Diagram	5
3.3 Connection Procedure.....	5
3.4 Application	6
4. Specification	7
4.1 Supported Resolution	8
5. Panel Drawing	9
6. Troubleshooting & Maintenance	10
7. After-sales Service.....	11

1. Introduction

1.1 Introduction to MPTP-T-101US

Compliant with HDMI 2.0 & HDCP 2.2, MPTP-T-101US is a 4K HDMI Extender set developed with the latest HDBaseT™ 2.0 technology to extend uncompressed HDMI video, audio, USB 2.0, control signals and PoC over a single CAT5e/6 cable. The unidirectional PoC compliant extender comes with only one power supply, which means that the Receiver can be powered via Transmitter to save installers time and added cost to installing a power outlet. Ideally designed for smart displays and KVM solutions fitting digital signage markets.

1.2 Features

- Compatible with HDMI2.0 and is backwards compatible with all previous HDMI standards(e.g. HDMI 1.4), delivers high-resolution AV signal(1080p 3D, 4Kx2K@60Hz)
- Support HDBT2.0, transmit 4Kx2K signal up to 100m over single CAT6 cable
- EDID Pass-Thru
- HDCP2.2 compliant
- Front panel status LEDs for power, link & HDCP
- USB & RS232 control
- Unidirectional PoC (Power over HDBaseT)

1.3 Packing List

- | | |
|---|------------------------|
| ✓ 1 x MPTP-T-101UST | ✓ 1 x MPTP-T-101USR |
| ✓ 4 x Detachable Mounting Ears | ✓ 8 x Screws |
| ✓ 1 x Power Adapter (DC 12V 2A) | ✓ 8 x Plastic Cushions |
| ✓ 2 x RS232 cables (Phoenix to 9 Pin D-Sub) | ✓ 1 x User manual |

 Confirm if the product and the accessories are all included, if not, please contact with the dealers.

2. Panel Description

2.1 MPTP-T-101UST

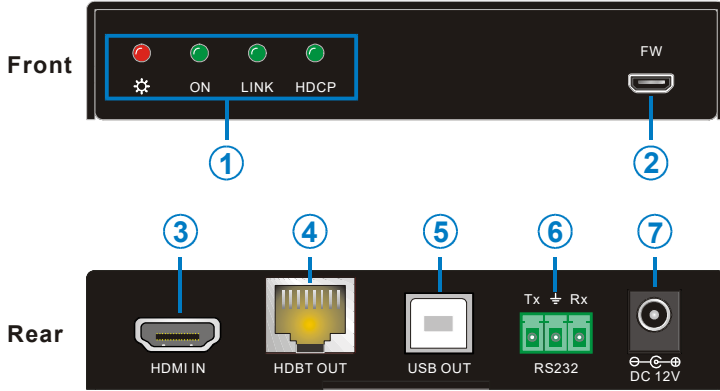

No.	Name	Description
①	Indicators	<p>Power:</p> <ul style="list-style-type: none"> ✓ OFF: No power ✓ RED: DC power present <p>ON: Working status indicator</p> <ul style="list-style-type: none"> ✓ OFF: Not operational ✓ Blinking GREEN: Normal operation <p>LINK: HDBT Link status indicator</p> <ul style="list-style-type: none"> ✓ OFF: No Link ✓ GREEN: Link successful ✓ Blinking GREEN: Link problem <p>HDCP: HDCP compliant indicator</p> <ul style="list-style-type: none"> ➤ OFF: No HDMI traffic(no picture) ➤ GREEN: HDMI signal with HDCP ➤ Blinking GREEN: HDMI signal without HDCP
②	FW	<p>Micro USB port, used for firmware update.</p> <p>Firmware updated need auxiliary equipment, please contact with our after-sales department for more details.</p>
③	HDMI IN	Connect with HDMI source.
④	HDBT OUT	Connect to the HDBT IN port on rear panel of MPTP-T-101USR via CAT5e/CAT6a cable, compliant with HDBT2.0 and support unidirectional PoC to power

		MPTP-T-101USR.
⑤	USB OUT	Type-B USB port, connect to PC to receive remote USB control
⑥	RS232	Serial port, connects with control device or device to be controlled, supports bi-directional RS232 control.
⑦	DC 12V	Connect with a DC12V 2A power adapter.

 Pictures for reference only, subject to our existing products.

2.2 MPTP-T-101USR

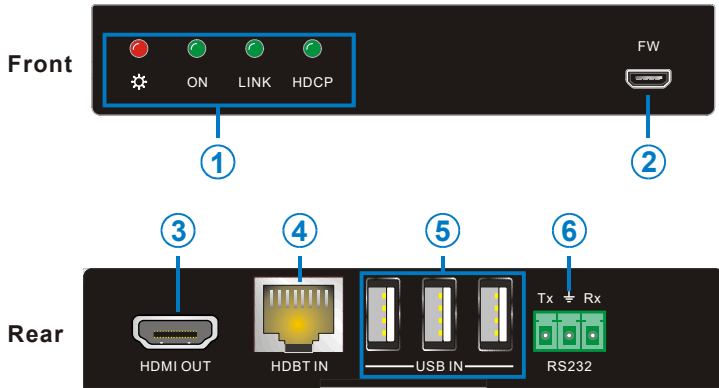

No.	Name	Description
①	Indicators	Power: ✓ OFF: No power ✓ RED: DC power present
		ON: Working status indicator ✓ OFF: Not operational ✓ Blinking GREEN: Normal operation
		LINK: HDBT Link status indicator ✓ OFF: No Link ✓ GREEN: Link successful ✓ Blinking GREEN: Link problem
		HDCP: HDCP compliant indicator ➤ OFF: No HDMI traffic(no picture) ➤ GREEN: HDMI signal with HDCP ➤ Blinking GREEN: HDMI signal without HDCP

HDBaseT 2.0 KVM Extender Set

②	FW	Micro USB port, used for firmware update. Firmware updated need auxiliary equipment, please contact with our after-sales department for more details.
③	HDMI OUT	Connect with HDMI display.
④	HDBT IN	Connect to the HDBT OUT port on the MPTP-T-101UST via CAT5e/ CAT6a cable, compliant with HDBT2.0.
⑤	USB IN	Type-A USB ports, connect to mouse/ keyboard/ U-disk for remote USB access.
⑥	RS232	Serial port, connects with control device or device to be controlled, supports bi-directional RS232 control.



Pictures for reference only, subject to our existing products.

3. System Connection

3.1 Usage Precautions

- 1) System should be installed in a clean environment and has a prop temperature and humidity.
- 2) All of the power switches, plugs, sockets and power cords should be insulated and safety.
- 3) All devices should be connected before power on.

3.2 System Diagram

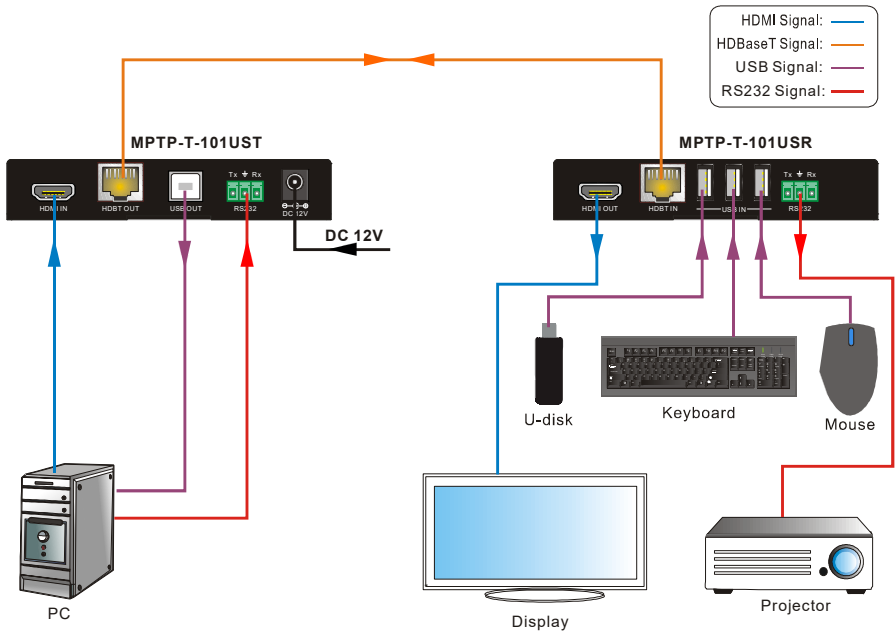

3.3 Connection Procedure

- Step1.** Connect HDMI source (such as PC) to **HDMI IN** port of MPTP-T-101UST with an HDMI cable.
- Step2.** Connect **HDBT OUT** port of MPTP-T-101UST to **HDBT IN** port of MPTP-T-101USR through a straight-thru CAT5e/CAT6 cable.
- Step3.** Connect a HDMI display to **HDMI OUT** port of MPTP-T-101USR with HDMI cable;
- Step4.** When using the USB control, do the following:

- a) Connect PC to the **USB OUT** port of MPTP-T-101UST.
- b) Connect Mouse/ Keyboard/U-disk to the **USB IN** port(s) of MPTP-T-101USR.

Step5. When using the bi-directional RS232 control, do the following:

- a) Connect PC to the RS232 port at either the MPTP-T-101UST or the MPTP-T-101USR.
- b) Connect a third-party device (such as projector) need to be controlled to the **RS232** port at the other end.
- c) Send RS232 commands to control the third-party device. For more details about RS232 commands, please refer to the user manual for the third-party device.

Step6. Connect with DC12V power adaptor to the power port of MPTP-T-101UST, MPTP-T-101USR will be powered synchronously via PoC.



- 1) System Diagram shown in this manual is for reference only, more specific schemes depend on real-time applications.
- 2) Connect HDBT ports via straight-thru CAT5e/6 cable with TIA/EIAT568B standard terminations at both ends.
- 3) RS232 communication protocol: Baud Rate: 9600; data bit: 8; stop bit: 1; parity: none. HDBT Transceiver receives RS232 control from devices with various baud rate (2400, 4800, 9600, 19200, 38400, 57600, 115200).
- 4) HDBT ports can work with our company's HDBT products that has same power supply solution.

3.4 Application

Compliant with HDBT2.0, MPTP-T-101US has a good application in occasions where high-definition AV distribution, long-distance transmission, Ethernet Switch are needed, such as computer realm, monitoring, big screen displaying, meeting room, education and bank & securities institution etc.

4. Specification

Model Spec	MPTP-T-101UST	MPTP-T-101USR
Audio& Video		
Input	1 HDMI (19 pin Type-A male)	1 HDBT (RJ45 female) 3 USB IN (Type-A)
Output	1 HDBT (RJ45 female) 1 USB OUT (Type-B)	1 HDMI (19 pin Type-A male)
Other	1 RS232 (3-pin pluggable terminal block)	1 RS232 (3-pin pluggable terminal block)
Signal Standard	HDMI2.0& HDCP2.2	HDMI2.0& HDCP2.2
Transmission Mode	HDBaseT 2.0	
HDMI Embedded audio	PCM/Dolby Digital/DTS/DTS-HD	
General		
EDID Management	EDID Pass-Thru	
Transmission Distance	4Kx2K≤100m(Cat6)	
Temperature	-10~ 55℃	
Reference Humidity	10% ~ 90%	
Power Supply	Input:100V~240V AC; Output: DC 12V 2A	
Power Consumption	18W(max)	
Dimension (W*H*D) (mm)	4.5"x 0.86" x 3.74" 116 x 22 x 95(mm)	4.5" x 0.86" x 3.74" 116 x 22 x 95(mm)
Net weight	197g	198g

 All nominal levels are at ±10%.

4.1 Supported Resolution

4Kx2K	4096x2160@30Hz, 3840x2160 (30Hz/24Hz/25Hz/50Hz/60Hz)
16:9	1080P 3D, 1920x1080@60Hz, 1600x900@60Hz, 1366x768@60Hz, 1280x720@60Hz, 1024x576@60Hz
16:10	1920x1200@60Hz, 1680x1050@60Hz, 1440x900@60Hz, 1360x768@60Hz, 1280x800@60Hz
4:3	1600x1200@60Hz, 1400x1050@60Hz, 1280x1204@60Hz, 1024x768@60Hz, 800x600@60Hz, 640x480@60Hz
21:9	2560x1080 (30/60Hz)

 HDBT Transceiver supports 4k&1080p 3D HDMI signal, please adopt quality HDMI cables compliant with HDMI2.0 for optimum range and performance.

5. Panel Drawing

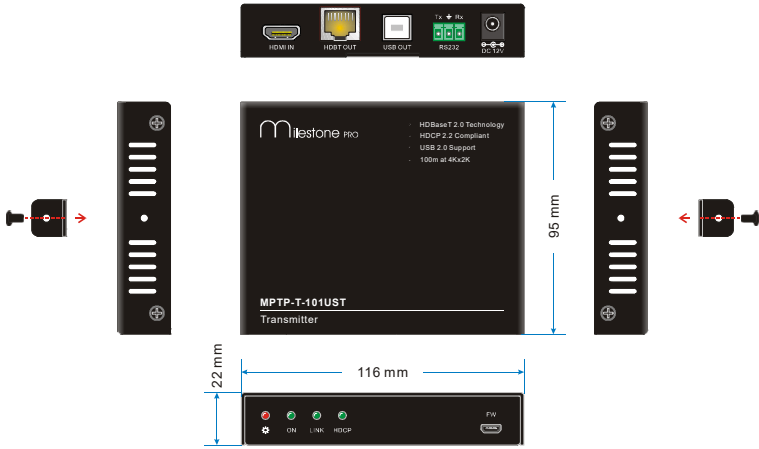

MPTP-T-101UST

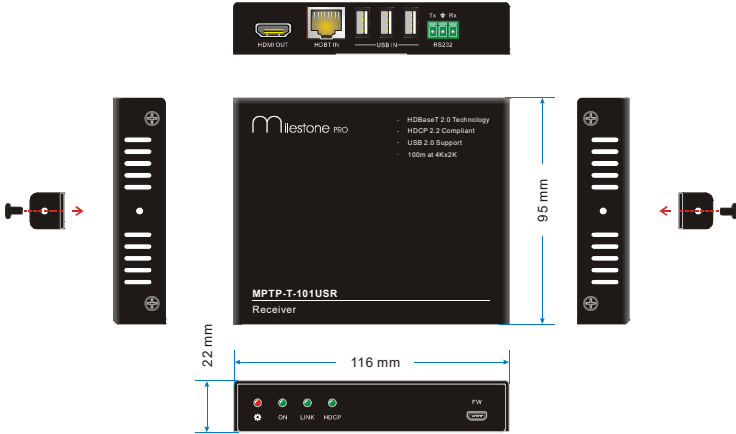

MPTP-T-101USR

6. Troubleshooting & Maintenance

Problems	Causes	Solutions
No reaction to any operation, power indicator is off	Haven't been powered on	Insert power adapter to Transmitter
Abnormal indication of the status LEDs	Wrong specification of the power adapter	Change for DC 12V 2A power adapter.
Color lose or poor picture quality	Signal loss caused by long transmission distance beyond effective value	Make sure the connecting cable is within 100m and of good quality.
	Bad quality of the HDMI cable	Ensure the HDMI cables used at source, Transmitter, Receiver and display are properly connected and are of good quality
Cannot use the device	the device is broken	Send it to authorized dealer for repairing.

If your problem persists after following the above troubleshooting steps, seek further help from authorized dealer or our technical support.

7. After-sales Service

If there appear some problems when running the device, please check and deal with the problems reference to this user manual.

1) Product Limited Warranty: We warrant that our products will be free from defects in materials and workmanship for **three years**, which starts from the first day the product leaves warehouse (check the SN mark on the product).

Proof of purchase in the form of a bill of sale or receipted invoice must be presented to obtain warranty service.

2) What the warranty does not cover:

- Warranty expiration.
- Factory applied serial number has been altered or removed from the product.
- Damage, deterioration or malfunction caused by:
 - Normal wear and tear
 - Use of supplies or parts not meeting our specifications
 - No certificate or invoice as the proof of warranty.
 - The product model showed on the warranty card does not match with the model of the product for repairing or had been altered.
 - Damage caused by force majeure.
 - Servicing not authorized
 - Other causes which does not relate to a product defect
- Delivery, installation or labor charges for installation or setup of the product

3) Technical Support: Email to our after-sales department or make a call, please inform us the following information about your cases.

- Product version and name.
- Detailed failure situations.
- The formation of the cases.

Remarks: For any questions or problems, please try to get help from your local distributor.